

Gemini

OR-K-GE1

Orbital Express Truss™ features over 40 professionally designed “off-the-shelf” kits for a variety of booth sizes and configurations. Each kit comes complete with all the parts, fixtures and fittings you need to create a successful exhibit, including (depending on the kit) low voltage spotlights and adjustable tabletops. A benefit to this versatile system is that it enables you to reconfigure kits in multiple ways and combinations using the same parts. Orbital Express Truss can also be easily customized!

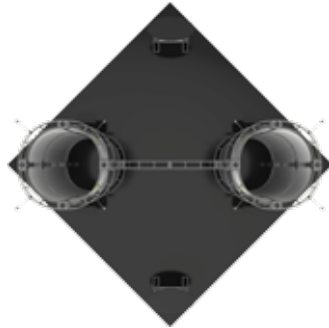

features and benefits:

- Kit includes:
 - 24 x 6-way junction boxes
 - 4 x 24" straight truss lengths
 - 4 x 30" straight truss lengths
 - 16 x 36" straight truss lengths
 - 12 x 46" straight truss lengths
 - 24 x 90° curved truss lengths
 - full set of quicklock connectors
 - 4 x junction bases
 - 4 x tabletops
 - 2 x counters
 - 8 x 50 watt spotlights
 - 4 x monitor mounts
- 1 x OCF2 molded case
- 1 x OCH2 molded case
- 2 x OCT molded cases
- 20' x 20' kit size
- Custom appearance
- Toolless assembly
- Simple twist and lock design
- 5 year warranty against manufacturer defects

dimensions:

Hardware:

Fits in a 20' x 20' space

Shipping:

1 OCF2 case:

51"l x 51"h x 23"d
1295mm(l) x 1295mm(h) x 584mm(d)

1 OCH2 case:

52"l x 29"h x 15"d
1321mm(l) x 737mm(h) x 381mm(d)

2 OCT cases (each case):

51"l x 51"h x 42"d
1295mm(l) x 1295mm(h) x 1067mm(d)

Approximate shipping weight:

1000 lbs / 454 kgs

additional information:

Graphic materials:
Dye sublimated or UV panels

Lumina 1, 50 watt spotlight

Counter: max weight = 35 lbs / 15.88 kgs

Tabletops (each): max weight
= 25 lbs / 11.34 kgs

Graphics:

Refer to related graphic template for specific information on sizes and bleeds. Dye-sublimated graphic require different bleed than UV.

Visit www.exhibitors-handbook.com/graphic-templates

Monitor mount holds 26" - 40" monitor;
maximum weight = 80 lbs / 36 kgs

*Kit does not include monitors

- Tabletop color options: (if applicable)



silver



black















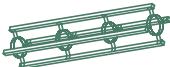



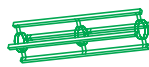
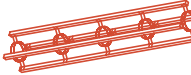

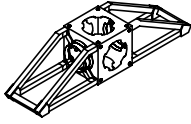
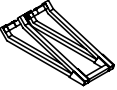



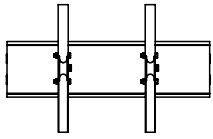

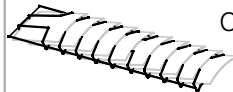
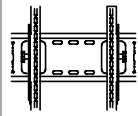
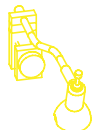
mahogany



natural

We are continually improving and modifying our product range and reserve the right to vary the specifications without prior notice. All dimensions and weights quoted are approximate and we accept no responsibility for variance. E&OE. See Graphic Templates for graphic bleed specifications.

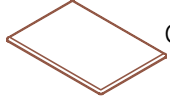
GEMINI PIECE COUNT:

 <p>OR-J-3 24</p>	 <p>OR-24-2 4</p>	 <p>OR-36-2 16</p>	 <p>OR-45-CV-3 0</p>	 <p>OR-B90 0</p>
 <p>OR-J-DBL 0</p>	 <p>OR-30-2 4</p>	 <p>OR-46-2 12</p>	 <p>OR-90-CV-2 24</p>	 <p>OR-B90A 4</p>
 <p>OR-B45 0</p>	 <p>OR-QL-T2J 96</p>	 <p>OR-UNC-QL 4</p>	 <p>OR-LCD1-B 0</p>	 <p>OR-LCD3-B 0</p>
 <p>OR-TOOL-B 3</p>	 <p>OR-QL-T2T 10</p>	 <p>OR-STG 0</p>	 <p>OR-LCD2-B 4</p>	
 <p>SPOTLIGHT 0</p>	 <p>OR-TBL2-L 0</p>	 <p>OR-IS-24 0</p>	 <p>OR-CIS-90 0</p>	 <p>OR-CIS-45 0</p>
 <p>OR-TBL 4</p>	 <p>OR-TBL2-R 0</p>	 <p>OR-IS-36 0</p>	 <p>OR-SE-IS-90 0</p>	 <p>OR-ATL-CNTR 0</p>
		 <p>OR-IS-46 0</p>		
		 <p>OR-IS-48 0</p>		

GEMINI TABLETOP ACCESSORY PIECE COUNT:

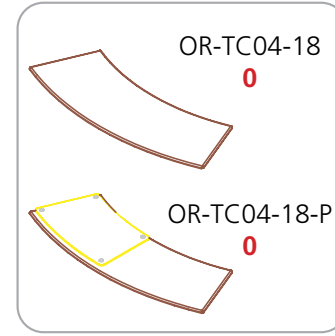
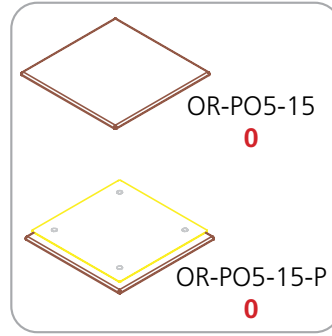
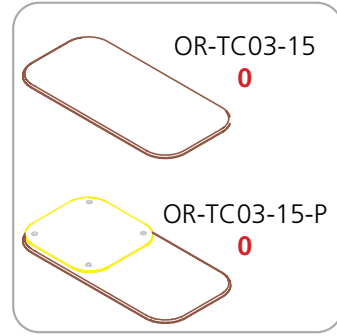
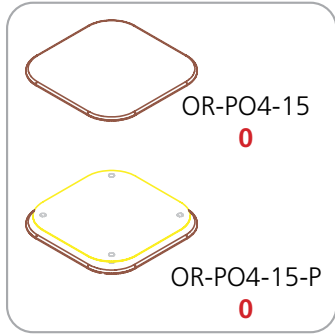
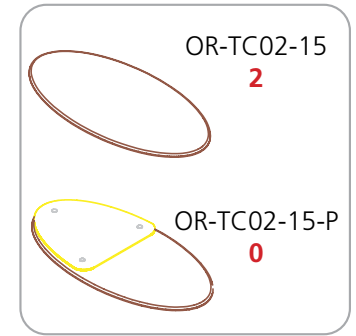
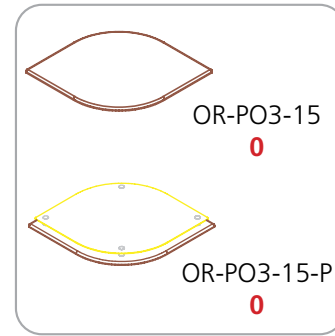
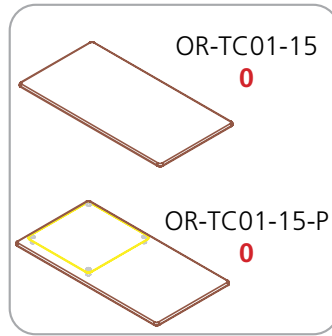
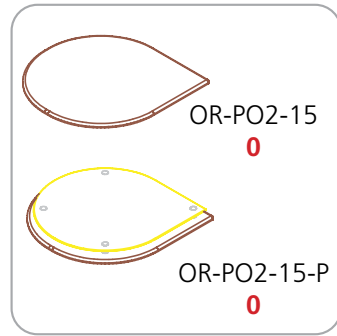
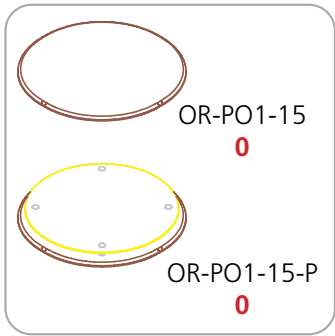

GEMINI CASE COUNT:

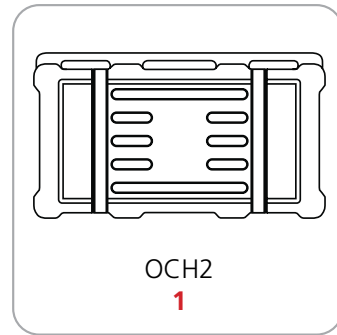
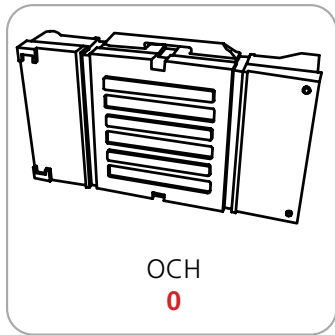
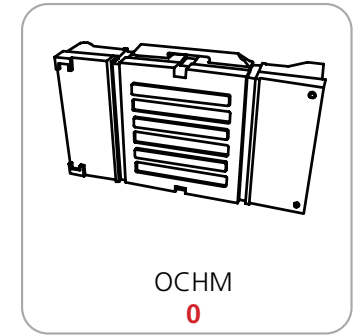
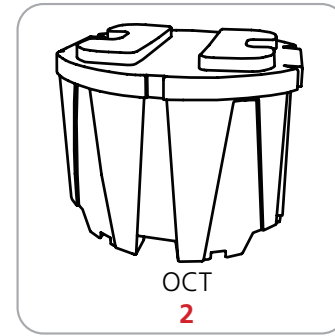
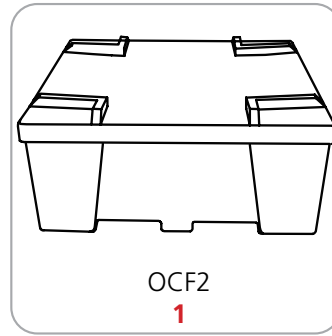
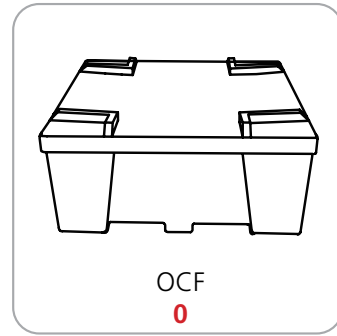
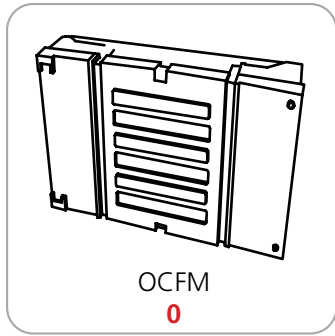

**GEMINI GRAPHIC SPECS:
AVAILABLE GRAPHICS – UV & DYE SUBLIMATION**

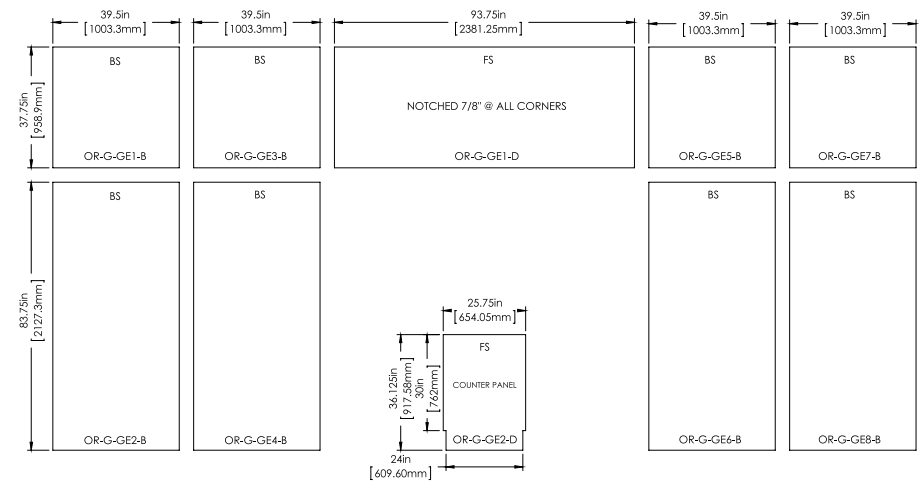
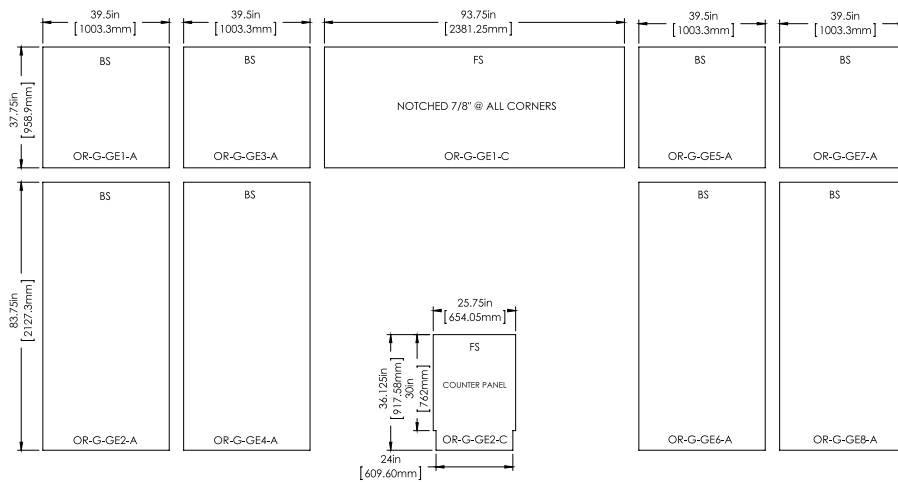

Acceptable File formats:

Illustrator CC or below
Photoshop CC or below
Art time will be charged if files need to be fixed or altered to meet guidelines. When sending files please be sure to include all support art (fonts, linked images, etc.)

Font Specifications:

Fonts must be converted to outlines.

Bleeds:

All orbital truss graphics require specific bleeds. The sizes listed above represent the finished graphic size. Please keep all logos, type and critical information at least 1" in from each edge of the finished graphic.

Dye Sublimation: 2" bleed around the perimeter.

UV: 1/2" bleed around the perimeter.

Color:

All files are printed as CMYK format. All critical Pantone colors need to be called out in the file or specified on the order as Coated or Uncoated swatches.

Resolution:

All raster files (either print files or linked files) must be at 100-120 pixels per inch at 100%

Finishing Details:

When graphics are notched, a 7/8" square is cut in the appropriate location.

FS: Graphics mounted to front of truss system

BS: Graphics mounted to back of truss system

Dye Sublimation graphics are attached to truss with velcro. UV panels are attached to truss with magnet.

To ensure quality, please note:

Each graphic has a specific code or number located on the graphic. The electronic print files provided must be named accordingly. Using this coding system will allow us to preflight and prepare your files for print more efficiently. **If you fail to provide your graphic files in this format, additional charges may be necessary to complete your printed materials.**

GEMINI GRAPHIC LAYOUT:

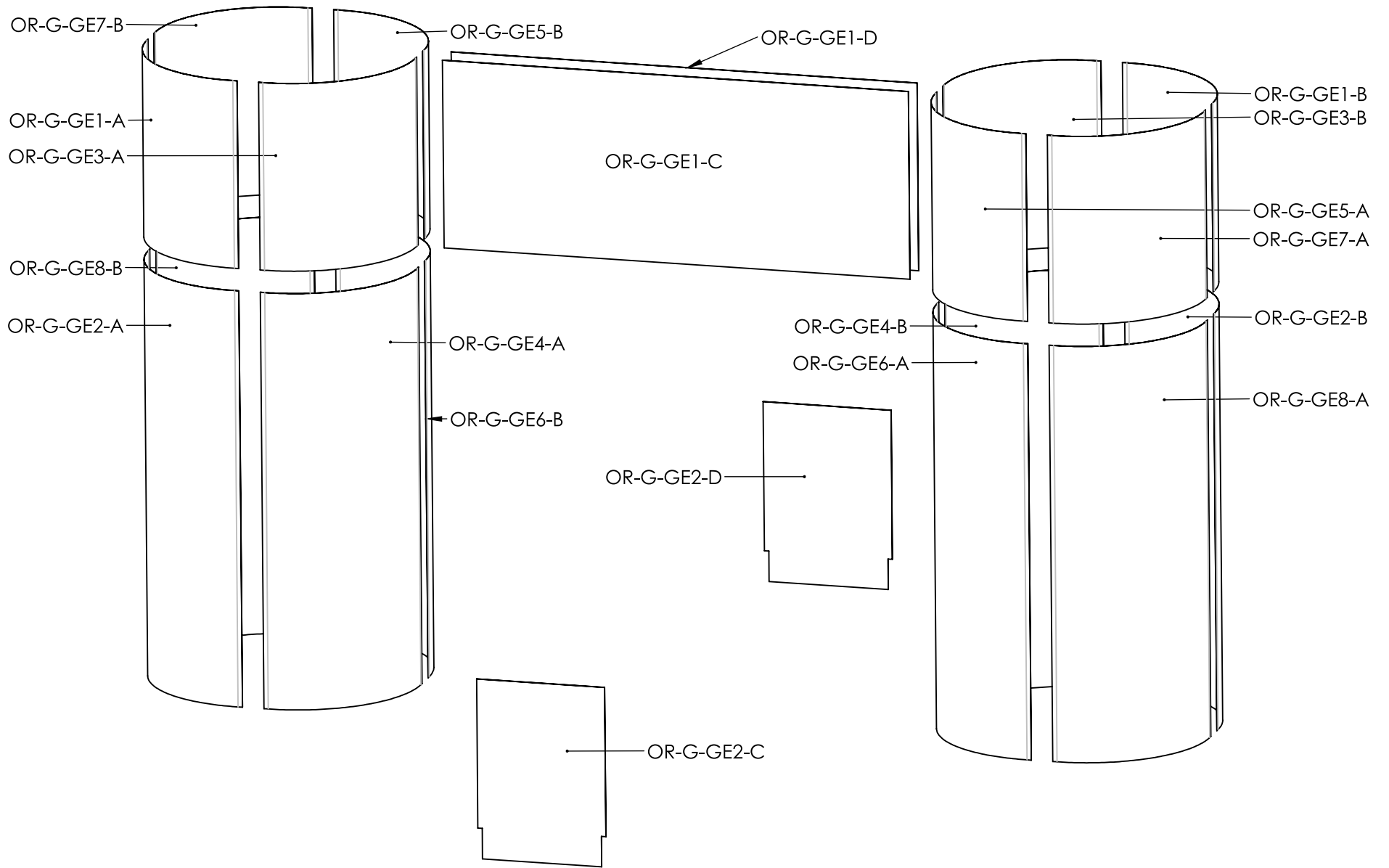

GEMINI GRAPHIC LAYOUT:

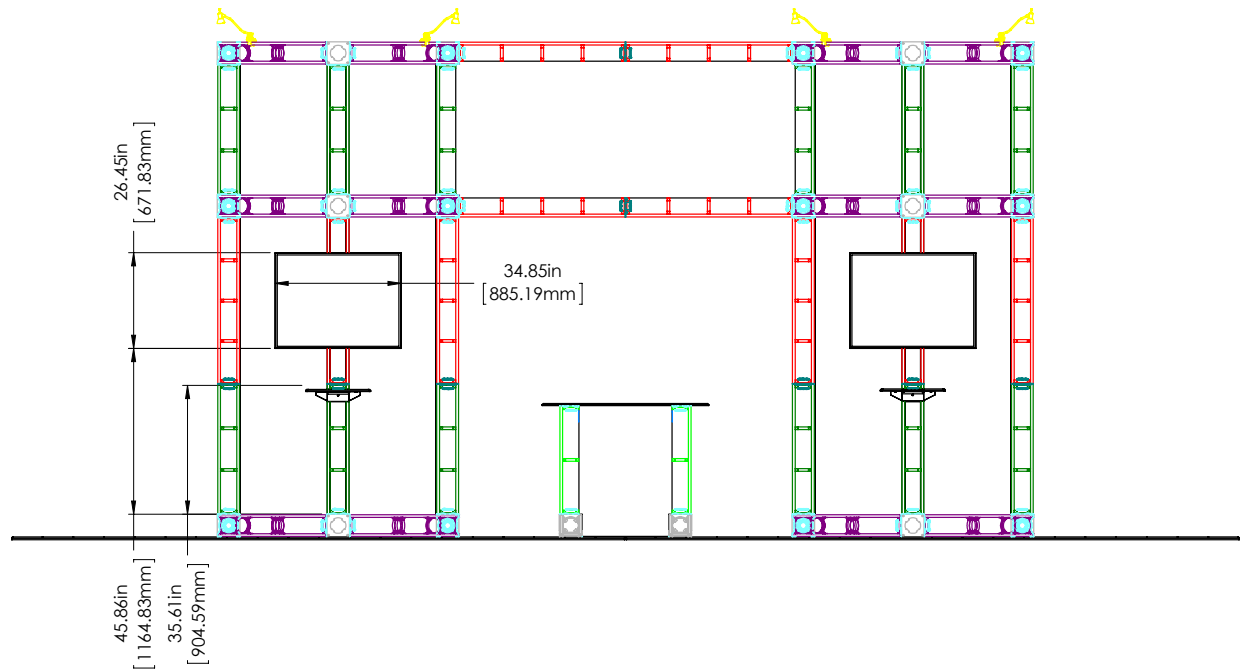
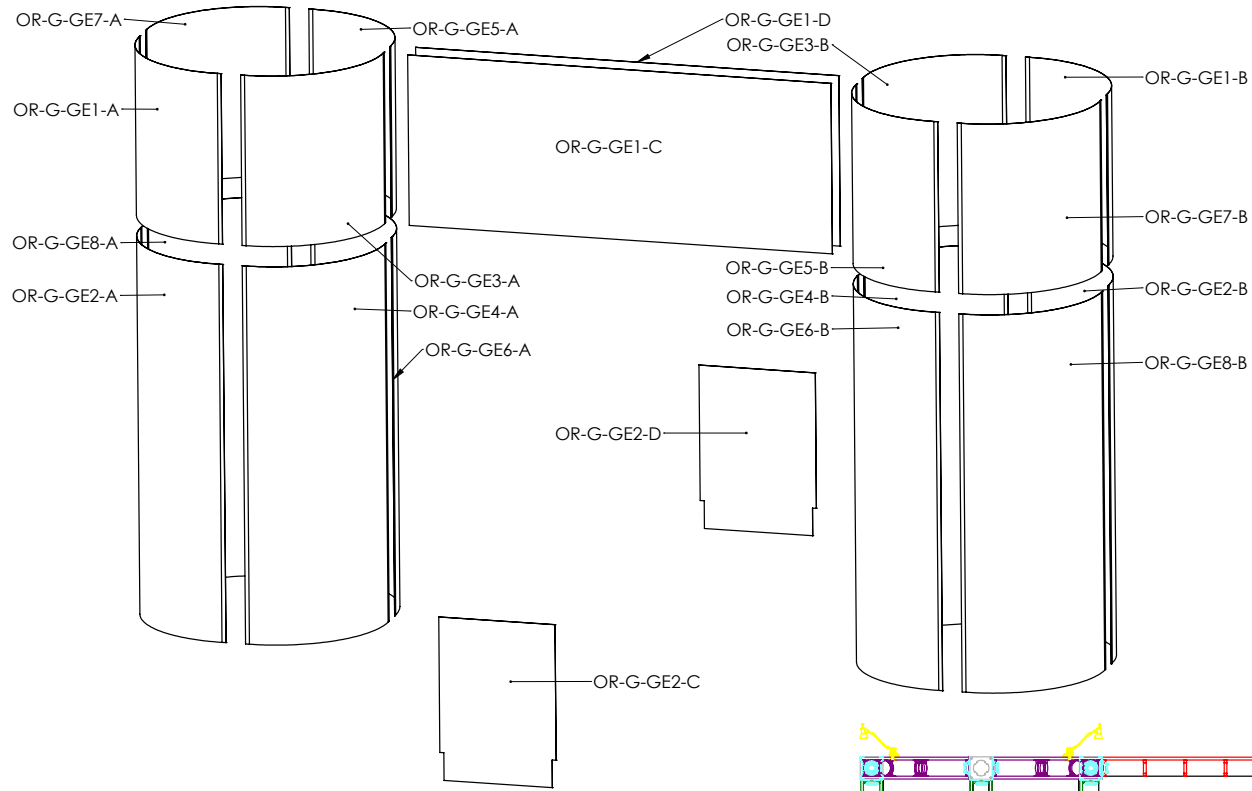

GEMINI FLOOR PLAN:

SCALE REF = 5ft



20'd x 20'w

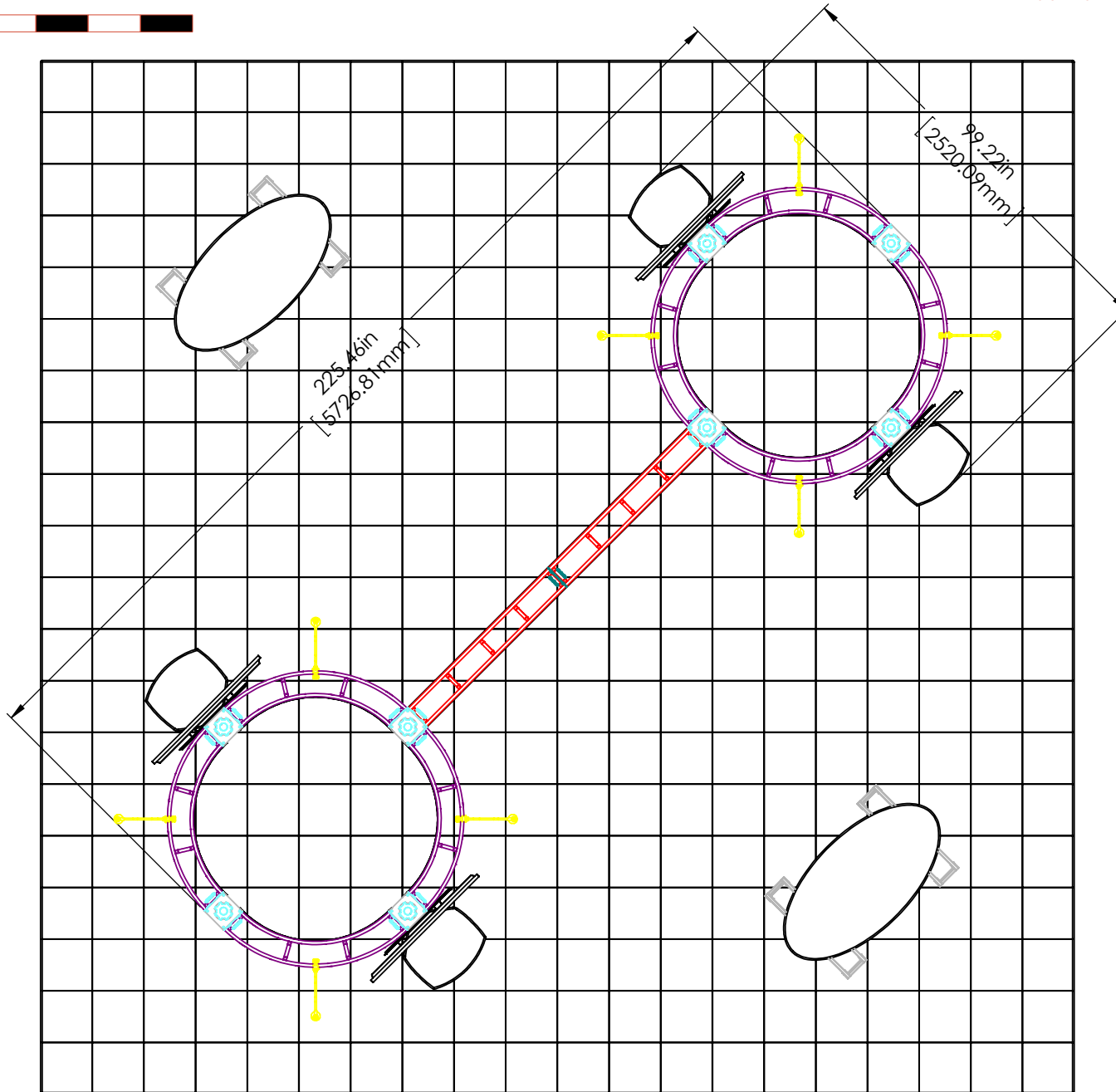

GEMINI COLOR CODED PARTS:

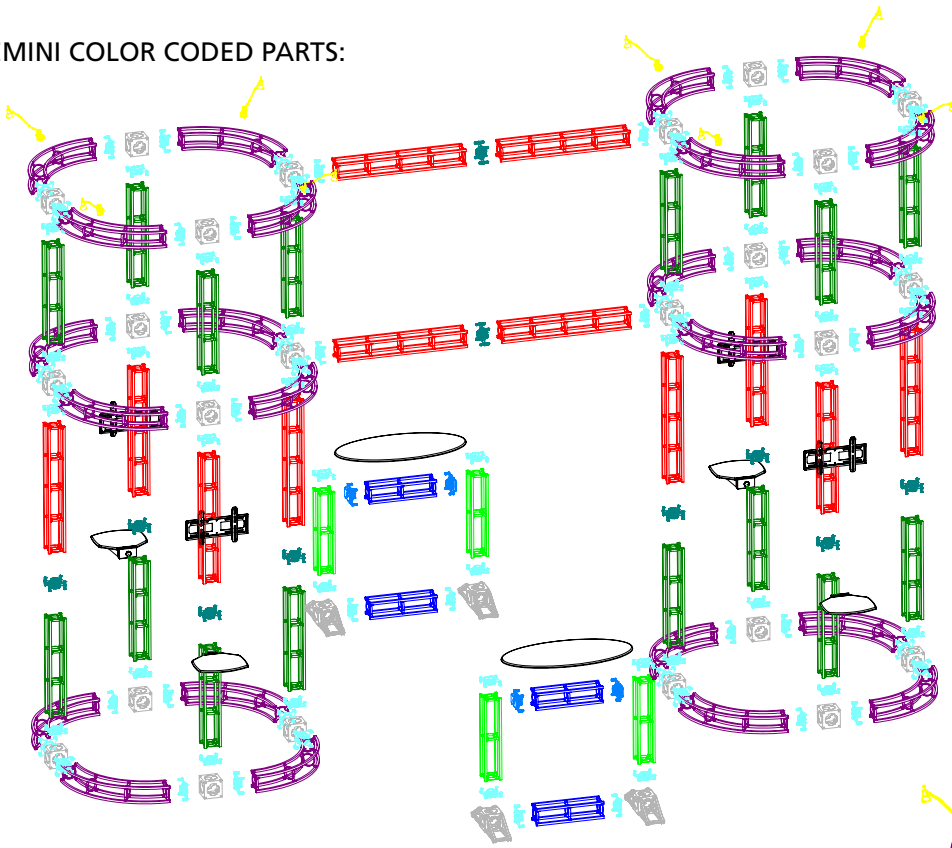

Parts exploded

